

CONTROL PANEL FOR 230 V GEARMOTORS

319U46EN



Official Partner



MILANO 2015
FEEDING THE PLANET
ENERGY FOR LIFE



Installation manual

ZA3N

“IMPORTANT INSTALLATION, SAFETY INSTRUCTIONS”

“CAUTION: IMPROPER INSTALLATION MAY CAUSE SERIOUS DAMAGE, FOLLOW ALL INSTALLATION INSTRUCTIONS CAREFULLY”

“THIS MANUAL IS ONLY FOR PROFESSIONAL OR QUALIFIED INSTALLERS”



1 Legend of symbols

- This symbol tells you what to say to the end-users.
- This symbol tells you that the sections concern safety issues.
- This symbol tells you what to say to the end-users.

2 Intended use and restrictions

2.1 Intended use

The ZA3N control panel is designed to control the 230V ATI, FERNI, KRONO, FAST and FROG swing gate operators.

- The use of this product for purposes other than those described above and installation executed in a manner other than as instructed in this technical manual are prohibited.

2.2 Limits to use

The overall power of the motors must not exceed 600W.

3 Reference standards

For its quality processes management CAME S.p.A. is ISO 9001:2008 certified, and for its environmental management it is ISO 14001:2004 certified. CAME engineers and manufactures all of its products in Italy.

This product complies with the following standards: see declaration of conformity.

4 Description

This product is engineered and manufactured by CAME S.p.A. and complies with current safety regulations.

The control panel works on 230V a.c. of power, 50/60Hz frequency.

The control devices and accessories are powered by 24V. Warning! The accessories must not exceed 20W overall.

All connections are protected by fast fuses, see table.

The board performs and controls the following functions:

- automatic closing after an opening command;
- pre-flashing of the flashing light;
- obstacle detection when gate is not running at any point;
- adjusting the motor torque on the connected automation device;
- ram blow in opening phase.

The command modes that may be defined are the following:

- opening/closing;
- opening/closing with maintained action;
- partial opening;
- complete stop.

Following an obstacle detection, the photocells can:

- reopening if the gate is closing;
- reclosing or partial stop if the gate is opening;
- partial stop if the gate is opening.

Expressly fitted trimmers adjust:

- duration of the automatic closing;
- M2 gearmotor closing delay;
- operating time.

It is also possible to connect:

- signalling lamps - gate open;
- cycle lamp;
- electric lock.

TECHNICAL FEATURES	
power supply	230V - 50/60Hz
max power	600W
power draw when idling	60 mA
max power of 24V accessories	20W
insulation rating	
casing material	ABS
casing protection rating	IP54
operating temperature	-20 / +55°C

FUSES TABLE	
protection:	fuse for:
Control board (line)	5A-F
Control devices and accessories (control unit)	3.15A-F

4.1 Dimensions, spans and anchoring holes

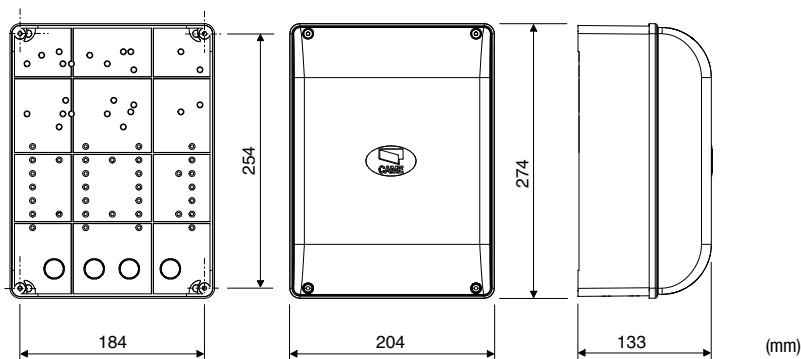

4.2 Main components

- 3 - Connection terminal boards
- 2 - Line fuse 5A
- 3 - Control unit fuse 3,15A
- 4 - Power up LED indicator 24V
- 5 - Buttons for memorising the radio code
- 6 - Operating time adjustment trimmer
- 7 - Trimmer for adjusting the automatic closure time
- 8 - Trimmer for adjusting the delay of M2 during closing and partial opening
- 9 - 10 DIP - Function selection
- 10 - Radio frequency card plug-in (see table)
- 11 - Signalling LED
- 12 - Torque limiter
- 13 - Condensers*

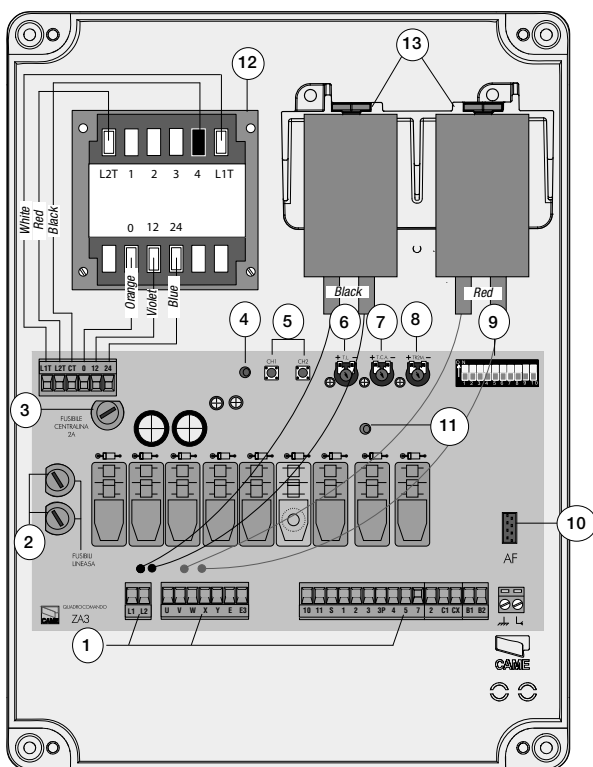

* Found in the 230V FROG box. Connected them up to the black (M1 motor) cables and red (M2 motor) cables fitted on the card; when coupling with Ati, Fast, Ferni and Krono devices the cables are not used because the condensers are already connected up inside.



Warning! Before acting on the machinery, cut off the main power supply.

5 Installation

5.1 Preliminary checks



Before installing, do the following:

- Check that the panel's anchoring point is protected from possible blows, and that the anchoring surface is solid. Also check that the anchoring is done using the appropriate bolts, screws etc.
- Make sure you have a suitable omnipolar cut-off device with contacts more than 3 mm apart, and independent (sectioned off) power supply.
-  Make sure that any connections inside the case (that provide continuance to the protective circuit) be fitted with extra insulation as compared to the other conductive parts inside.
- Make sure you have suitable tubing and conduits for the electrical cables to pass through and be protected against mechanical damage.

5.2 Tools and materials

Make sure you have all the tools and materials you will need for the installation at hand to work in total safety and compliance with the current standards and regulations.

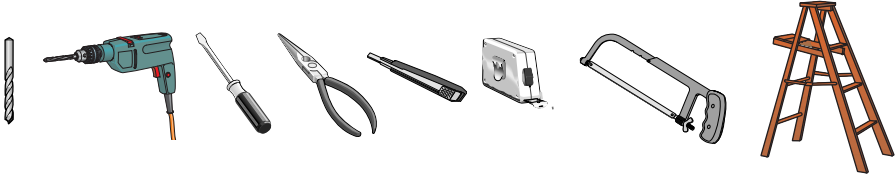

5.3 Fixing and mounting the casing

Fix the base of the panel in a protected area; we suggest using round top Phillips recessed head screws of max. 6mm in diameter.

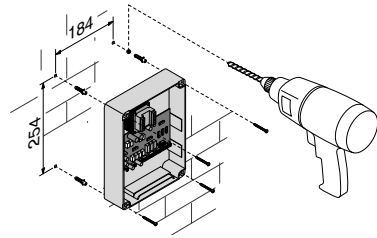

Perforate the pre-punched holes and insert the cable glands with the corrugated tubing for the electrical cables to travel through.

N.B.: the pre-punched holes have the following diameters: 23, 29 e 37 mm.

Be careful not to damage the control board inside the control panel!!

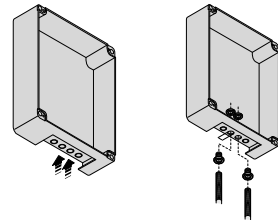

After the adjustments and settings, fix the cover using the provided screws.

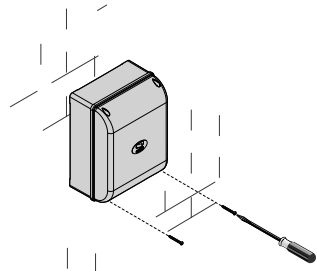

6 Electrical connections

Gearmotor

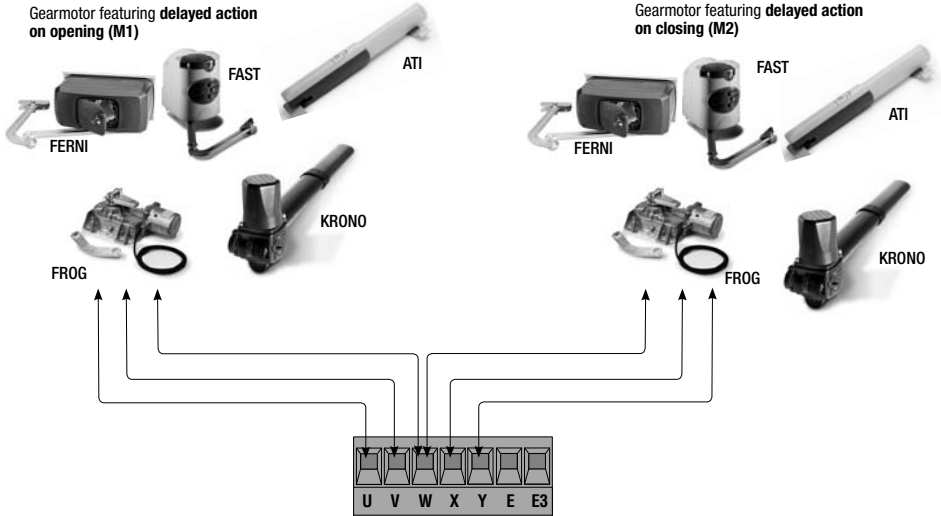

Standard opening setup scheme in Came gearmotors.

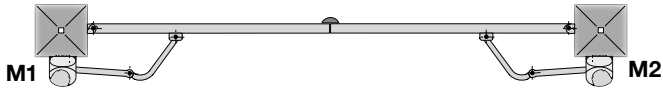

When using only one motor (e.g. on one leaf gates), connect it up on W X Y (M2) regardless of which side it is installed on – (fro FROG, if need be, invert connections X and Y).

Accessories power supply

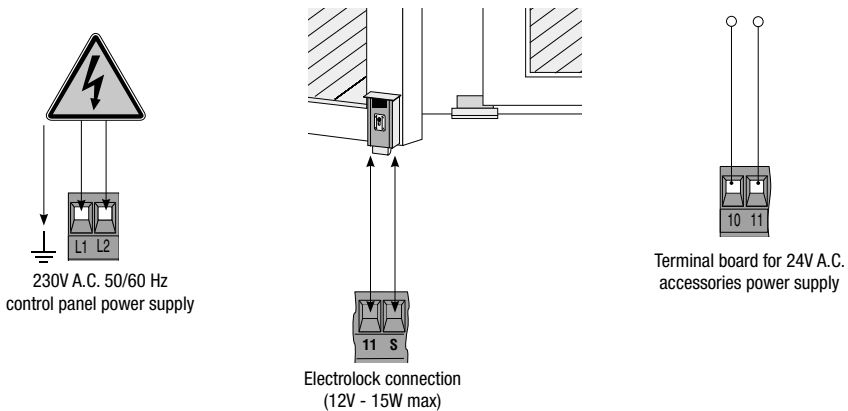

Open gate light-indicator (Socket rating: 24V - 3W max.). Turns on when the gate is open. It turns off when the gate is closed.

Flashing light (Socket rating: 230V A.C. - 25W max.)
- Flashes during opening and closing phases.

Cycle lamp connection (230V-60W)

This lamp lights up the vehicle maneuvering area and stays on from the moment the gate leaves start opening until total stop takes place (including automatic closing time). If the automatic closure is not inserted it stays lit up only while it is moving.

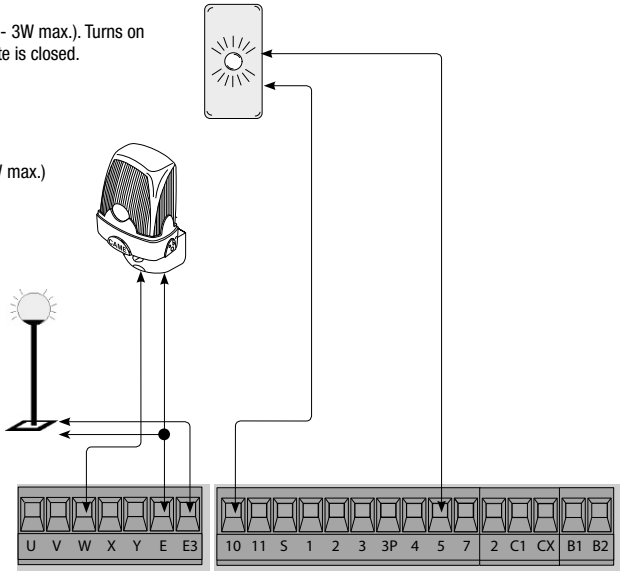

Control devices

Stop button (N.C. contact)

- Gate stop button excluding automatic closing cycle; to start up movement again press the command button or the transmitter button. (Bridge if unused)

Keyswitch and/or open button (N.O. contact)

- Gate opening command.

Keyswitch and/or partial open button (N.O. contact)

- One gate leaf opening command to allow pedestrian passage (M2 opens).

Keyswitch and/or close button (N.O. contact)

- Gate closing command.

Keyswitch and/or comand button (N.O. contact)

- Gate opening/closing command. By pressing the button or turning the selector key, the gate inverts its movement or stops depending on the choice you have made on the Dip-switch (see selecting functions, Dips 2 and 3).

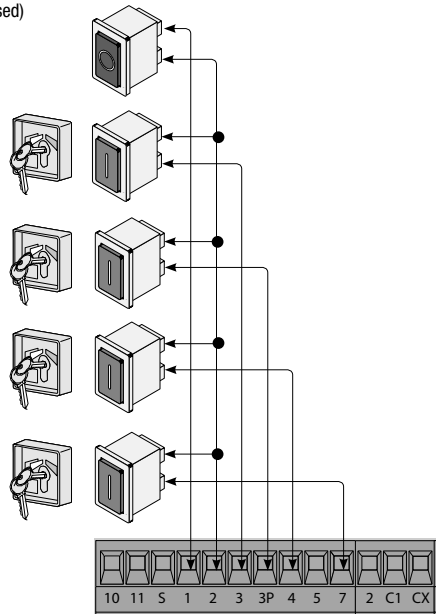

Safety devices

(N.C.) contact for «re-opening during closing»
 - Input for safety devices such as photocells, sensitive edges and other EN 12978-compliant devices. During the gate leaves closing phase, opening the contact causes movement inversion until fully opened.
 If unused set DIP switch n.9 to ON

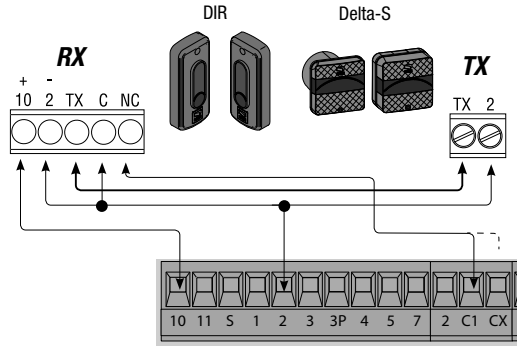

(N.C.) contact of «re-closing during opening»
 - Input for safety devices such as photocells, sensitive edges and other EN 12978-compliant devices. During the gate leaves closing phase, opening the contact causes movement inversion until fully closed.
 Dip 8 OFF - 10 OFF



Or

(N.C.) contact for «partial stop»
 - Input for safety devices such as photocells, sensitive edges and other EN 12978-compliant devices. Gate leaves are stopped if in motion, with consequent setup of automatic closing.
 Dip 8 OFF - 10 ON
 If unused set DIP switch n.8 to ON

(N.C.) contact for «re-opening during closing»

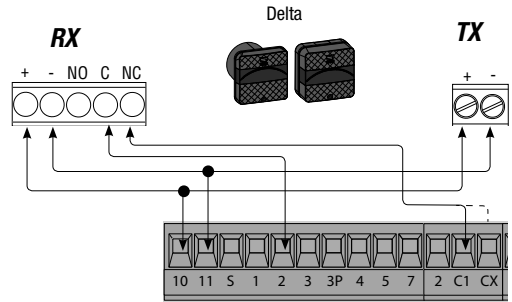

(N.C.) contact for «re-closing during opening»

Or

(N.C.) contact of «partial stop»



7 Selecting functions

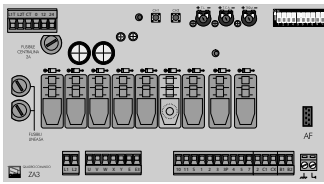

DIP-SWITCH 10 WAYS

ON
OFF



- 1 ON Automatic closing activated (1 OFF-disactivated);
- 2 ON "Open-stop-close-stop" function with button (2-7) and radio control (with built-in AF card) - activated;
- 2 OFF "Open-close" function with button (2-7) and transmitter (with built-in AF card) - activated;
- 3 ON "Open only" function with transmitter (built-in AF card) - activated (3 OFF-disactivated);
- 4 ON Pre-Flashing during opening and closing – activated (4 OFF- disactivated);
- 5 ON Obstacle detection - activated (5 OFF- disactivated);
- 6 OFF "Maintained action" (the transmitter cannot work) deactivated (6 ON - activated);
- 7 ON Ram blow activated; at each opening command, the gate leaves press when against the closing jamb for a second, helping to release the electro-lock connected up on terminals 11-S. It is active only if the leaves are closed and when operating time is over, or upon the 1st run after powering up the system;
- 8 OFF - 10 OFF Re-close during opening function (connect the safety device on 2-CX) - activated;
- 8 OFF - 10 ON Partial stop function (connect the safety device on 2-CX) - activated (if the devices on 2-CX are not used, set the DIP 8 in ON);
- 9 OFF Re-open during closing function - activated; connect the safety device on 2-C1 (if the device on 2-CX is not used, et the DIP in ON).

8 Adjustments

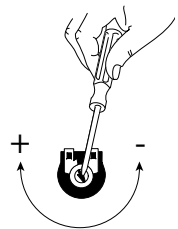
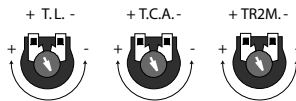
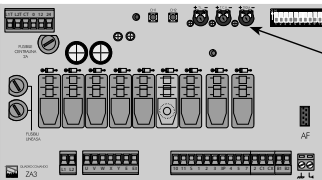

- Trimmer T.L.** = Adjusting the working time from 10" to 120".
- Trimmer T.C.A.** = Adjusting the automatic closing from 1" to 120".
- Trimmer TR2M** = Adjusting the M2 closing delay (min. 0", max. 15") and simultaneous partial opening (min. 0", max. 30").

9 Motor torque limiter

To vary the motor torque, shift the shown faston to one of the 4 positions: 1 min., 4 max.

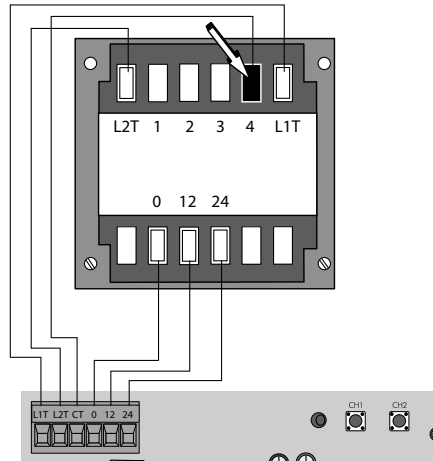

10 Activating the radio control

Antenna

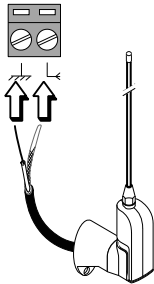

Connect the antenna's RG58 cable to the apposite terminals.



Possible output of the radio receiver's second channel (N.O. contact).
Socket rating: 5A-24V D.C.

Radio frequency card

Only for cards marked on the table:

- place the jumper as shown depending on the series of transmitters used. (see diagram).

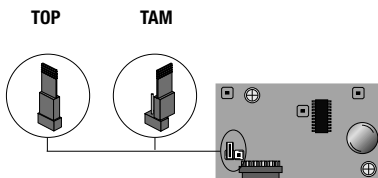

Frequency/Mhz	Radio frequency card	Transmitters series
FM 26.995	AF130	TFM
FM 30.900	AF150	TFM
AM 26.995	AF26	TOP
AM 30.900	AF30	TOP
AM 433.92	AF43S / AF43SM	TAM / TOP
AM 433.92	AF43TW	TWIN (KeyBlock)
AM 433.92	AF43SR	ATOMO
AM 40.685	AF40	TOUCH
AM 863.35	AF868	TOP

Transmitters

ATOMO

AT01 • AT02
AT04



see instructions attached to
AF43SR card

TOUCH

TCH 4024 • TCH 4048

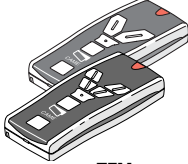

TFM

T132 • T134 • T138
T152 • T154 • T158

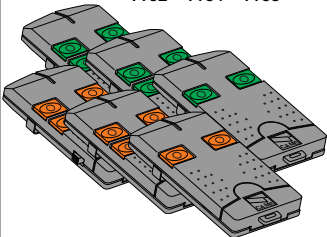

TAM

T432 • T434 • T438
TAM-432SA

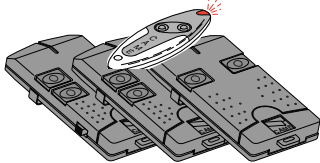

see attached instructions

TOP

TOP-432NA • TOP-434NA
TOP-862NA • TOP-864NA
TOP-432S



TOP

TOP-432A • TOP-434A
TOP-302A • TOP-304A

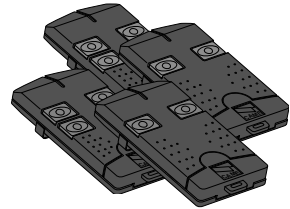

TWIN

TWIN2 • TWIN4

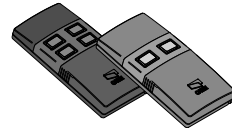

Lock the radiofrequency card into the electronic card **AFTER CUTTING OFF THE POWER SUPPLY** (or after disconnecting the batteries).
N.B.: The control board only recognises the radiofrequency card when the power is on.

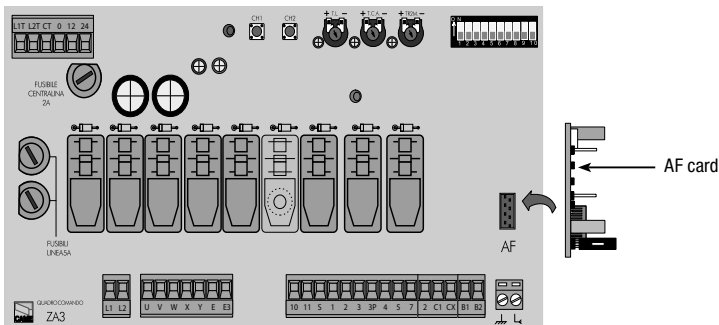

Memorisation

CH1 = Channel for direct command to a function of the the gearmotor's card, ("open only / "open-close-invert" or "open-stop-close-stop" command, depending on the choice made on DIP switches 2 and 3).

CH2 = Channel for direct command an accessory device connected to B1-B2.

1) Keep the **CH1** button on the electronic card pressed. The LED flashes. Press the transmitter button you wish to memorise. The LED will stay on to show memorisation has been successful.

2) Perform the same procedure with the CH2 button coupling it to another button on the transmitter.

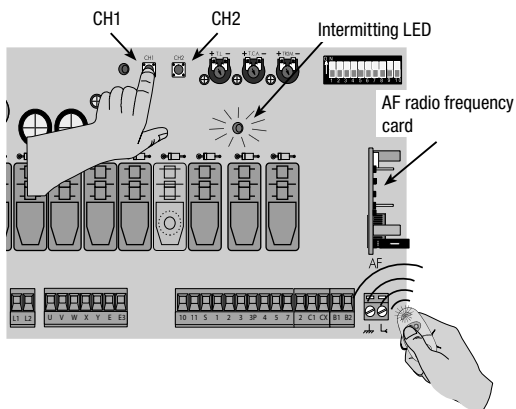

11 Phasing out and disposal

 In its premises, CAME S.p.A. implements an Environmental Management System certified in compliance with the UNI EN ISO 14001:2004 standard to ensure environmental protection.

Please continue our efforts to protect the environment—which CAME considers one of the cardinal elements in the development of its operational and market strategies—simply by observing brief recommendations as regards disposal:

DISPOSAL OF PACKAGING

The packaging components (cardboard, plastic, etc.) are all classifiable as solid urban waste products and may be disposed of easily, keeping in mind recycling possibilities.

Prior to disposal, it is always advisable to check specific regulations in force in the place of installation.

PLEASE DISPOSE OF PROPERLY!

PRODUCT DISPOSAL

Our products are made up of various types of materials. Most of them (aluminium, plastics, iron, electrical wires, etc.) may be disposed of in normal garbage collection bins and can be recycled by disposing of in specific recyclable material collection bins and disposal in authorized centres. Other components (electrical boards, remote control batteries, etc.), however, may contain polluting substances. They should therefore be removed and given to qualified service companies for proper disposal.

Prior to disposal, it is always advisable to check specific regulations in force in the place of disposal.

PLEASE DISPOSE OF PROPERLY!

12 DECLARATION OF CONFORMITY

Declaration  CAME S.p.A. declares that this product conforms to the essential, pertinent requirements provided by directives 2006/95/CE and 2004/108/CE.

An original copy of the declaration of conformity is available on request.

CAME
safety & comfort



parkare

Came S.p.A.

Via Martiri Della Libertà, 15

31030 **Dossan di Casier**
Treviso - Italy

☎ (+39) 0422 4940

✉ (+39) 0422 4941

Via Cornia, 1/b - 1/c

33079 **Sesto al Reghena**
Pordenone - Italy

☎ (+39) 0434 698111

✉ (+39) 0434 698434

www.came.com